

Disposición de los contactos

Contact arrangement



Disp. Arrang.	Cl. isol. Rating	Dim. Contactos / Contact size							
		4/0	0	4	8	12	16	18	
10SL - 3	A						3		
- 4	A						2		
12S - 3	A						2		
12 - 5	A					1			
14S - 1	A						3		
- 2	I						4		
- 4	D						1		
- 5	I						5		
- 6	I						6		
- 7	A						3		
- 9	A						2		
14 - 07	I						7		
16S - 1	A						7		
- 3	B						1		
- 4	D						2		
- 5	A						3		
- 6	A						3		
- 8	A						5		
16 - 2	E					1			
- 7	A				1		2		
- 9	A					2	2		
- 10	A					3			
- 11	A					2			
- 12	A			1					
- A10	I							10	
18 - 1	I						10		
- 3	D					2			
- 4	D						4		
- 5	D					2	1		
- 6	D			1					
- 06	A					4	2		
- 7	B				1				
- 8	A					1	7		
- 9	I					2	5		
- 10	A					4			
- 11	A					5			
- 12	A						6		
- 13	A				1	3			
- 14	A			1			1		
- 16	C					1			
- 19	A						10		
- 20	A						5		
- 22	D						3		
- 29	A						5		
20 - 2	D		1						
- 3	D					3			
- 4	D					4			
- 6	D						3		
- 7	A						8		
- 8	I				2		4		
- 9	A					1	7		
- 11	I						13		
- 12	A			1			1		
- 14	A				2	3			
- 15	A					7			
- 16	A					2	7		
- 17	A					5	1		

Disp. Arrang.	Cl. isol. Rating	Dim. Contactos / Contact size							
		4/0	0	4	8	12	16	18	
20 - 18	A						3	6	
- 19	A				3				
- 20	A			1		3			
- 21	A					1	8		
- 22	A				3		3		
- 23	A				2				
- 24	A				2		2		
- 27	A						14		
- 29	A						17		
- 33	A						11		
- A9	I						9		
- A48	I							19	
22 - 1	D				2				
- 2	D				3				
- 4	A				2	2			
- 5	D					2	4		
- 6	D				2		1		
- 7	E		1						
- 8	E					2			
- 9	E					3			
- 10	E						4		
- 11	B						2		
- 12	D				2		3		
- 13	D					4	1		
- 14	A						19		
- 15	A					5	1		
- 16	A					3	6		
- 17	A					1	8		
- 18	A						8		
- 19	A						14		
- 20	A						9		
- 21	A		1				2		
- 22	A				4				
- 23	A					8			
- 24	A					2	4		
- 27	A				1		8		
- 28	A					7			
- 33	A						7		
- 34	D					3	2		
- 82	A				2		8		
- A10	A						10		
- A37	A							37	
24 - 2	D					7			
- 3	A					2	5		
- 4	A		1				3		
- 5	A						16		
- 06	D				4		2		
- 6	A					8			
- 07	D					7			
- 7	A					2	14		
- 9	A			2					
- 10	A				7				
- 11	A				3	6			
- 12	A			2		3			
- 013	A					6	7		
- 16	A				1	3	3		
- 17	D					2	3		

Disposición de los contactos Contact arrangement

Disp. Arrang.	Cl. isol. Rating	Dim. Contactos / Contact size						
		4/0	0	4	8	12	16	18
24 - 19	A						12	
- 20	D					2	9	
- 21	D				1		9	
- 22	D				4			
- 27	E						7	
- 28	I						24	
- 67	A					19		
- A 1	B	1						
- A 25	A						25	
- A 28	I						28	
28 - 1	A				3	6		
- 2	D					2	12	
- 3	E				3			
- 4	D					2	7	
- 5	D			2		1	2	
- 6	D			3				
- 7	D			2				
- 8	A					2	10	
- 09	A			4			5	
- 9	D					6	6	
- 10	A			2	2	3		
- 11	A					4	18	
- 12	A						26	
- 15	A						35	
- 16	A						20	
- 17	A						15	
- 18	I						12	
- 19	A					4	6	
- 20	A					10	4	
- 21	A						37	
- 22	D			3			3	
- 70	A				7			
- 124	A				4		12	
- A 31	A				6			25
- A 35	A						35	
- A 63	I					9	19	
- B 1	B	1						
32 - 1	D	2				3		
- 2	E		3				2	
- 3	D	1	2			2	4	
- 4	I					2	12	
- 5	D	2						
- 6	A		2	3	2		16	
- 7	I					7	28	
- 8	A					6	24	
- 9	D		2				12	
- 10	A		2	2			3	
- 12	A					5	10	
- 013	D					13		
- 13	D					5	18	
- 15	D	2				6		
- 17	D		4					
- 22	A						54	
- 31	A						31	
-59	A			2			40	
- 68	A		4				12	
- 689	A		3				6	

Disp. Arrang.	Cl. isol. Rating	Dim. Contacto / Contact size						
		4/0	0	4	8	12	16	18
32 - 79	D			4	1			
- 88	A						54	
- A 1	A	1						
- A 3	E			3				
- A 25	A					25		
- A 27	A					10	17	
- A 30	A					10	20	
- A 48	I						48	
- B 22	A			2			20	
36 - 01	C	1						
- 1	D					4	18	
- 3	D		3			3		
- 4	A		3					
- 5	A		4					
- 6	A		2	4				
- 7	A					7	40	
- 8	A					1	46	
- 9	A			1	2	14	14	
- 10	A						48	
- 13	A					2	15	
- 14	D				5	5	6	
- 15	A						35	
- 20	A				2	2	30	
- 22	D					22		
-35	A				4		32	
- 74	A				1		43	
- A 51	D		3	2			1	
- A 72	I					4	16	52
- B 78	D					12	2	
- D 78	D					10	4	
40 - 1	D					6	24	
- 9	A				1	22	24	
- 10	A			4	9		16	
- 26	A				7	19		
- 31	D					31		
- 35	D					35		
- 47	A				1	22	24	
- 53	A						60	
- 56	A						85	
- 62	A						60	
- 63	A						61	
-67	A			10			1	
- 150	I							150
- 951	A					25	26	
- A 3	A		3			2		
- A 4	A		4			2		
- A 5	A		3	1		1		
- A 6	B					6		
- A 10	D			4			4	
- A 38	A					38		
- A 51	A				15		16	
- A 56	A						85	
- A 62	A				2		60	
- A 65	A						65	
- B 4	E		4					
- B 19	A					19		

Posiciones alternativas

Alternate positions



D i s p . A r r a n g .	g r a d o s / d e g r e e s a ±2°			
	W	X	Y	Z
1 2 S - 3	70	145	215	290
1 4 S - 1	90	180	270	
- 2		120	240	
- 5		110		
- 6	90			
- 7	90	180	270	
- 9	70	145	215	290
1 6 S - 1	80			280
- 4	35	110	250	325
- 5	70	145	215	290
- 6	90	180	270	
- 8		170	265	
- 7	80	110	250	280
- 9	35	110	250	325
- 10	90	180	270	
- 11	35	110	250	325
- A 10	35	112	235	315
1 8 - 1	70	145	215	290
- 3	35	110	250	325
- 4	35	110	250	325
- 5	80	110	250	280
- 06		180		
- 8	70			290
- 9	80	110	250	280
- 10		120	240	
- 11		170	265	
- 12	80			280
- 13	80	110	250	280
- 14	80	110	250	280
- 19		120	240	
- 20	90	180	270	
- 22	70	145	215	290
- 29	90	180	270	
2 0 - 3	70	145	215	290
- 4	45	110	250	
- 6	70	145	215	290
- 7	80	110	250	280
- 8	80	110	250	280
- 9	80	110	250	280
- 12	80	110	250	280
- 14	80	110	250	280
- 15	80			280
- 16	80	110	250	280
- 17	90	180	270	
- 18	35	110	250	325
- 19	90	180	270	
- 20	80	110	250	280
- 21	35	110	250	325
- 22	80	110	250	280
- 23	35	110	250	325
- 24	35	110	250	325
- 27	35	110	250	325
- 29	80			280
- 33				280
- A 9		110	250	

D i s p . A r r a n g .	g r a d o s / d e g r e e s a ±2°			
	W	X	Y	Z
2 0 - A 4 8		80	280	
2 2 - 1	35	110	250	325
- 2	70	145	215	290
- 4	35	110	250	325
- 5	35	110	250	325
- 6	80	110	250	280
- 8	35	110	250	325
- 9	70	145	215	290
- 10	35	110	250	325
- 11	35	110	250	325
- 12	80	110	250	280
- 13	35	110	250	325
- 14	80	110	250	280
- 15	80	110	250	280
- 16	80	110	250	280
- 17	80	110	250	280
- 18	80	110	250	280
- 19	80	110	250	280
- 20	35	110	250	325
- 21	80	110	250	280
- 22		110	250	
- 23	35		250	
- 24	80	110	250	280
- 27	80		250	280
- 28	80			280
- 33	80	110	250	280
- 34	80	110	250	280
- A 10		120	240	
- A 37	80	112	250	280
2 4 - 2	80			280
- 3	80	110	250	280
- 4	80	110	250	280
- 5	80	110	250	280
- 6	80	110	250	280
- 07	80			280
- 7	80	110	250	280
- 9	35	110	250	325
- 10	80			280
- 11	35	110	250	325
- 12	80	110	250	280
- 16	80	110	250	280
- 17	80	110	250	280
- 20	80	110	250	280
- 21	80	110	250	280
- 22	45	110	250	
- 27	80			280
- 28	80	110	250	280
- 67	80			335
- A 25	80	110	250	280
- A 28	65	146	235	
2 8 - 1	80	110	250	280
- 2	35	110	250	325
- 3	70	145	215	290
- 4	80	110	250	280
- 5	35	110	250	325

Disp. Arrang.	grados / degrees $\alpha \pm 2^\circ$			
	W	X	Y	Z
3 2 - A 2 7	30	115	285	335
- A 4 8	80			
- B 2 2	35	110	250	325
3 6 - 1	80	110	250	280
- 3	70	145	215	290
- 4	70	145	215	290
- 5		120	240	
- 6	35	110	250	325
- 7	80	110	250	280
- 8	80	110	250	280
- 9	80	125	235	280
- 10	80	125	235	280
- 13	80	110	250	280
- 14	90	180	270	
- 15	60	125	245	305
- 2 2	80	110	250	280
- A 5 1	45	135	225	315
- A 7 2		110		
4 0 - 1	65	130	235	300
- 9	65	125	225	310
- 10	65	125	225	310
- 2 6	80	110	250	280
- 3 1	80	110	250	280
- 3 5	70	130	230	290
- 4 7	65	125	225	310
- 5 3	80	110	250	280
- 5 6	72	144	216	288
- 6 2	30	130	220	290
- 6 3	80			280
- A 3	70	145	215	290
- A 4	50	120	240	325
- A 5	33			270
- A 3 8	37	74	285	322
- A 5 6	72	144	216	288
- A 6 2	80	130	230	280
- A 6 5	70	145	215	285
- B 4	45	110		
- B 1 9	35	105	255	325

Disp. Arrang.	grados / degrees $\alpha \pm 2^\circ$			
	W	X	Y	Z
3 2 - A 2 7	30	115	285	335
- A 4 8	80			
- B 2 2	35	110	250	325
3 6 - 1	80	110	250	280
- 3	70	145	215	290
- 4	70	145	215	290
- 5		120	240	
- 6	35	110	250	325
- 7	80	110	250	280
- 8	80	110	250	280
- 9	80	125	235	280
- 10	80	125	235	280
- 13	80	110	250	280
- 14	90	180	270	
- 15	60	125	245	305
- 2 2	80	110	250	280
- A 5 1	45	135	225	315
- A 7 2		110		
4 0 - 1	65	130	235	300
- 9	65	125	225	310
- 10	65	125	225	310
- 2 6	80	110	250	280
- 3 1	80	110	250	280
- 3 5	70	130	230	290
- 4 7	65	125	225	310
- 5 3	80	110	250	280
- 5 6	72	144	216	288
- 6 2	30	130	220	290
- 6 3	80			280
- A 3	70	145	215	290
- A 4	50	120	240	325
- A 5	33			270
- A 3 8	37	74	285	322
- A 5 6	72	144	216	288
- A 6 2	80	130	230	280
- A 6 5	70	145	215	285
- B 4	45	110		
- B 1 9	35	105	255	325

Rotación del Inserto (vista de frente) / Insert rotation (front view)

Posición normal

Normal position

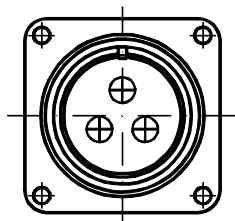

Posición alternativa con contactos hembras

Alternate position with socket contacts

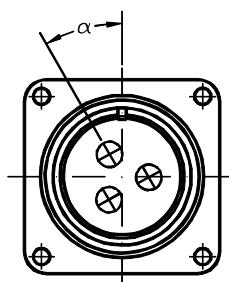

Posición alternativa con contactos machos

Alternate position with pin contacts

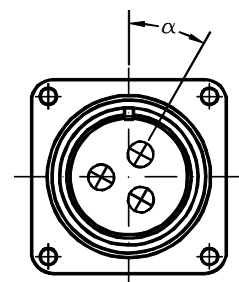

Disposición de los contactos

Contact arrangement

Vista anterior inserción macho

Front view of male insert



1 CONTACTO 1 CONTACT

DISPOSICIÓN
TAMAÑO CONTACTO
RANGO DE SERVICIO

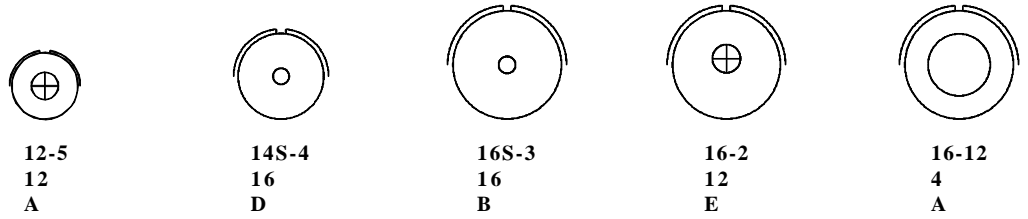

ARRANGEMENT
CONTACT SIZE
SERVICE RATING

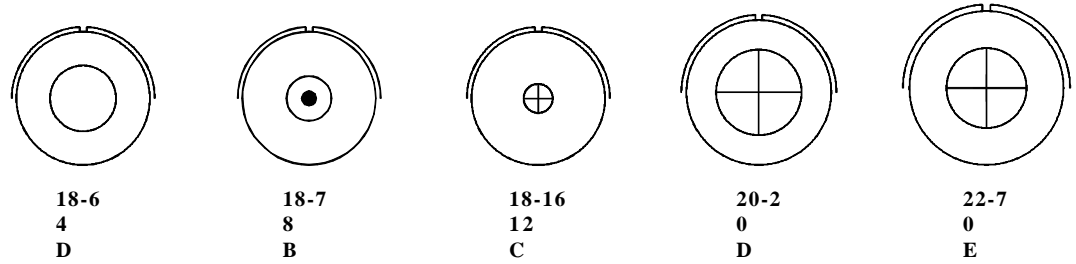

DISPOSICIÓN
TAMAÑO DE CONTACTO
RANGO DE SERVICIO

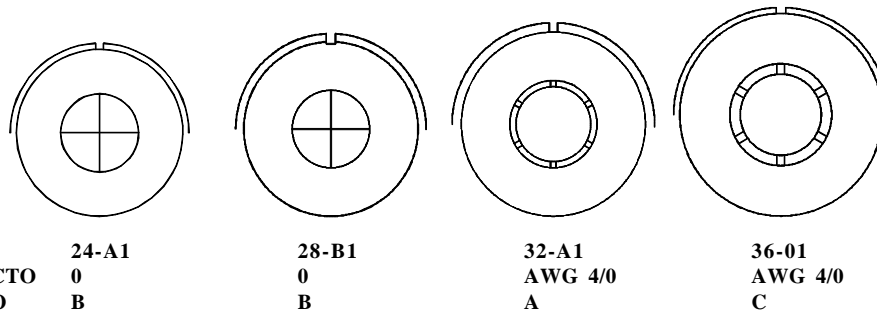

2 CONTACTOS 2 CONTACTS

ARRANGEMENT
CONTACT SIZE
SERVICE RATING

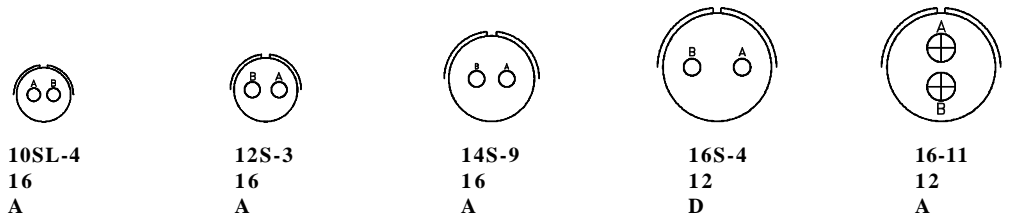

DISPOSICIÓN
TAMAÑO DE CONTACTO
RANGO DE SERVICIO

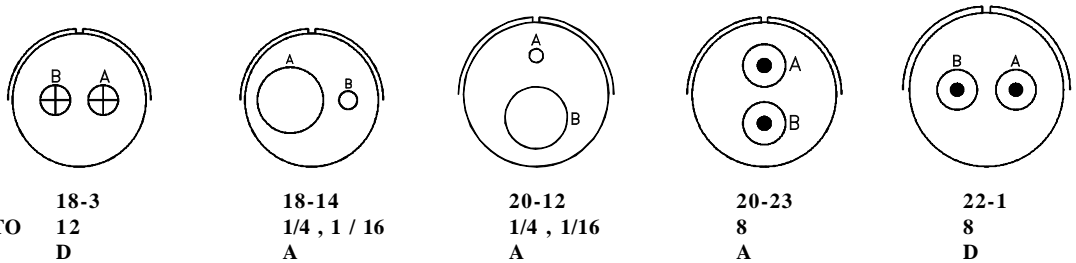

SÍMBOLO DE LOS CONTACTOS
CONTACT LEGEND

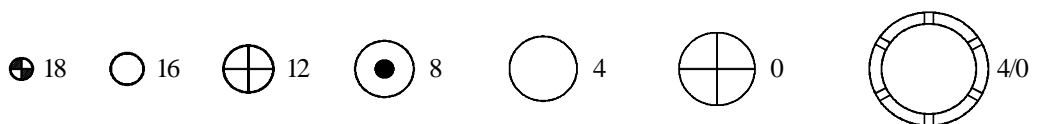

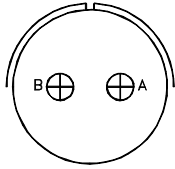
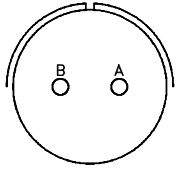
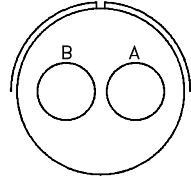
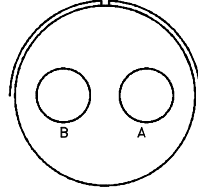
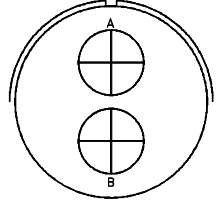
					
DISPOSICIÓN	22-8	22-11	24-9	28-7	32-5
TAMAÑO CONTACTO	12	16	4	4	0
RANGO DE SERVICIO	E	B	A	D	D

3 CONTACTOS

3 CONTACTS

ARRANGEMENT
CONTACT SIZE
SERVICE RATING

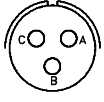
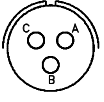
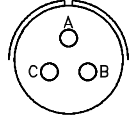
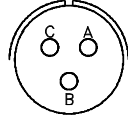
				
10SL-3	14S-1	14S-7	16S-5	16S-6
16	16	16	16	16
A	A	A	A	A

DISPOSICIÓN
TAMAÑO DE CONTACTO
RANGO DE SERVICIO

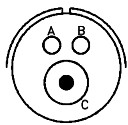
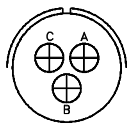
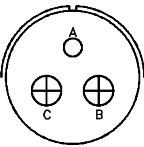
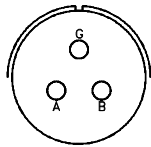
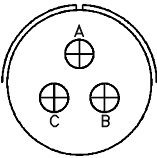
				
16-7	16-10	18-5	18-22	20-3
1/8 , 2/16	12	2/12 , 1/16	16	12
A	A	D	D	D

ARRANGEMENT
CONTACT SIZE
SERVICE RATING

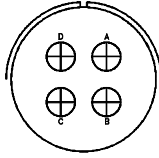
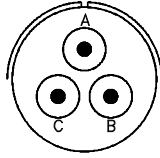
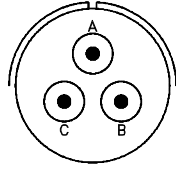
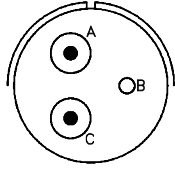
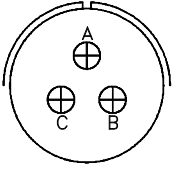
				
20-6	20-19	22-2	22-6	22-9
16	8	8	2/8 , 1 / 16	12
D	A	D	D	E

DISPOSICIÓN
TAMAÑO DE CONTACTO
RANGO DE SERVICIO

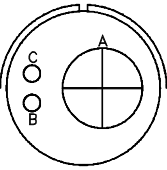
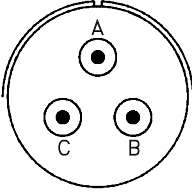
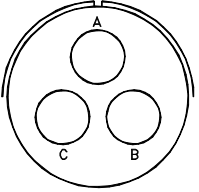
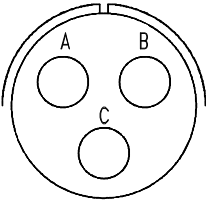
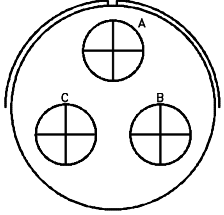
				
22-21	28-3	28-6	32-A3	36-4
1/0 , 2/16	8	4	4	0
A	E	D	E	A=D ; B,C=A

SÍMBOLO DE LOS CONTACTOS
CONTACTLEGEND

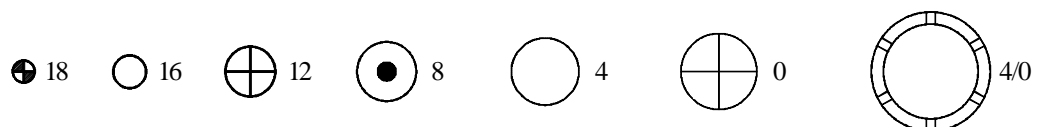

Disposición de los contactos Contact arrangement

4 CONTACTOS 4 CONTACTS

DISPOSICIÓN
TAMAÑO DE CONTACTO
RANGO DE SERVICIO

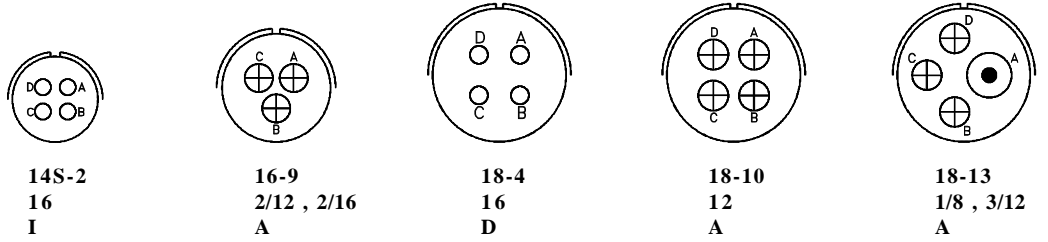

ARRANGEMENT
CONTACT SIZE
SERVICE RATING

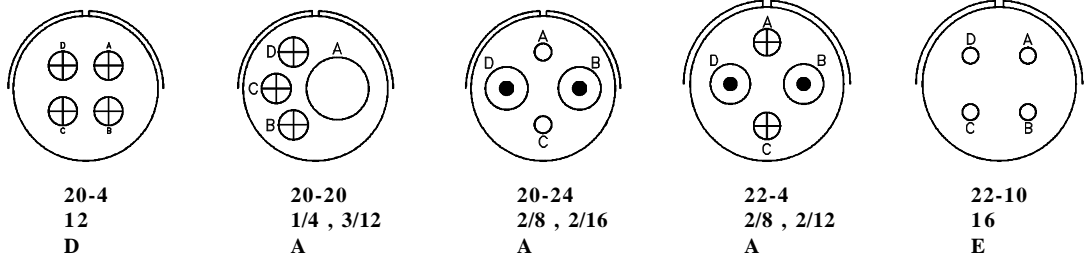

DISPOSICIÓN
TAMAÑO DE CONTACTO
RANGO DE SERVICIO

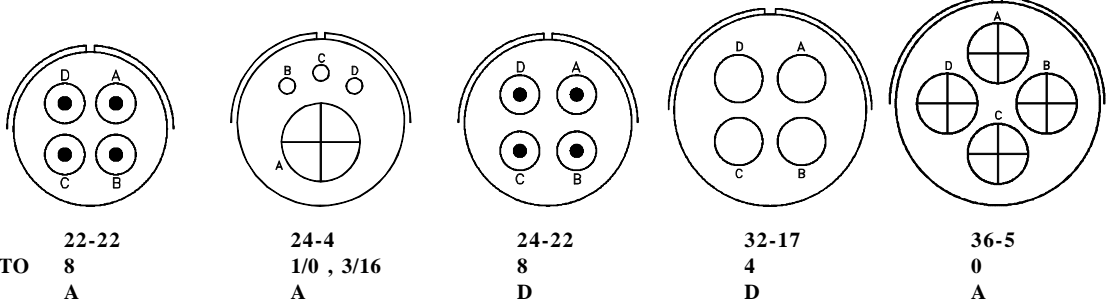

ARRANGEMENT
CONTACT SIZE
SERVICE RATING

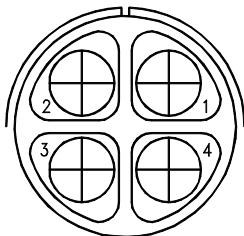

5 CONTACTOS 5 CONTACTS

DISPOSICIÓN
TAMAÑO CONTACTOS
RANGO DE SERVICIO

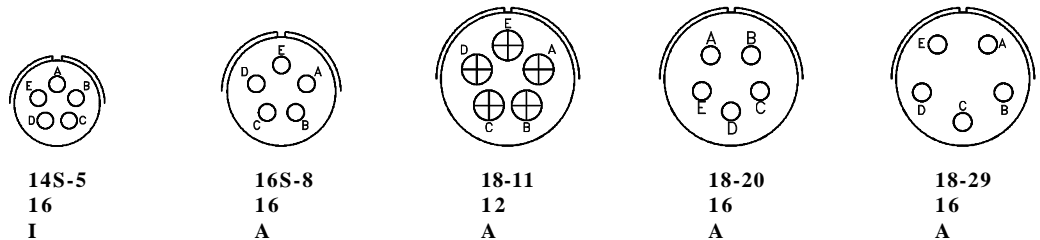

SÍMBOLO DE LOS CONTACTOS
CONTACT LEGEND

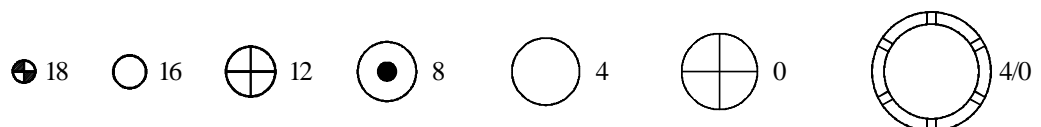

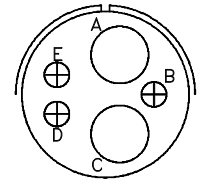
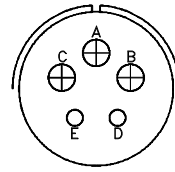
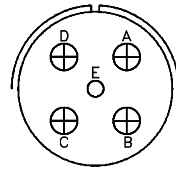
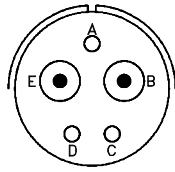
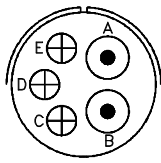

DISPOSICIÓN **20-14**
TAMAÑO CONTACTOS **2/8 , 3/12**
RANGO DE SERVICIO **A**

DISPOSICIÓN **22-12**
TAMAÑO CONTACTOS **2/8 , 3/16**
RANGO DE SERVICIO **D**

DISPOSICIÓN **22-13**
TAMAÑO CONTACTOS **4/12 , 1/16**
RANGO DE SERVICIO **D**

DISPOSICIÓN **22-34**
TAMAÑO CONTACTOS **3/12 , 2/16**
RANGO DE SERVICIO **D**

DISPOSICIÓN **24-12**
TAMAÑO CONTACTOS **2/4 , 3/12**
RANGO DE SERVICIO **A**

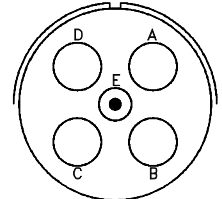
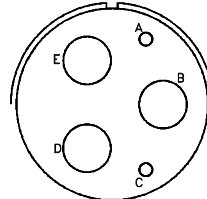
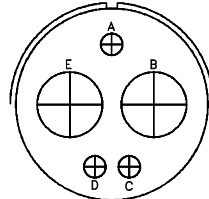
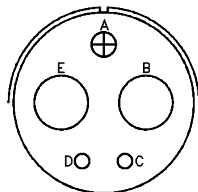
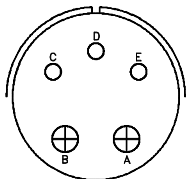

ARRANGEMENT **24-17**
CONTACT SIZE **2/12 , 3/16**
SERVICE RATING **D**

ARRANGEMENT **28-5**
CONTACT SIZE **2/4 , 1/12 , 2/16**
SERVICE RATING **D**

ARRANGEMENT **32-1**
CONTACT SIZE **2/0 , 3/12**
SERVICE RATING **A=E ; B,C,D,E=D**

ARRANGEMENT **32-2**
CONTACT SIZE **3/4 , 2/16**
SERVICE RATING **E**

ARRANGEMENT **32-79**
CONTACT SIZE **4/4 , 1/8**
SERVICE RATING **D**

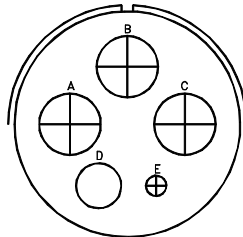
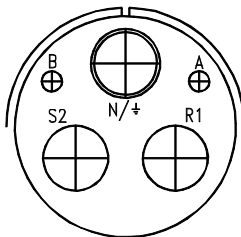

DISPOSICIÓN **40-A3**
TAMAÑO CONTACTOS **1/0M , 2/0 , 2/12**
RANGO DE SERVICIO **A**

DISPOSICIÓN **40-A5**
TAMAÑO CONTACTOS **3/0 , 1/4 , 1/12**
RANGO DE SERVICIO **A**

6 CONTACTOS

6 CONTACTS

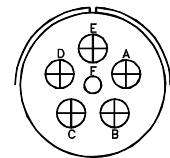
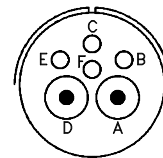
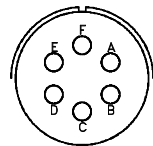
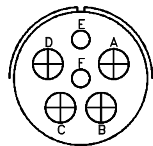
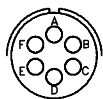

ARRANGEMENT **14S-6**
CONTACT SIZE **16**
SERVICE RATING **I**

ARRANGEMENT **18-06**
CONTACT SIZE **4/12 , 2/16**
SERVICE RATING **A**

ARRANGEMENT **18-12**
CONTACT SIZE **16**
SERVICE RATING **A**

ARRANGEMENT **20-8**
CONTACT SIZE **2/8 , 4/16**
SERVICE RATING **I**

ARRANGEMENT **20-17**
CONTACT SIZE **5/12 , 1/16**
SERVICE RATING **A**

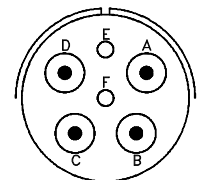
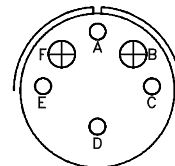
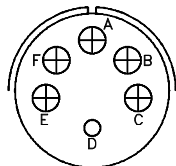
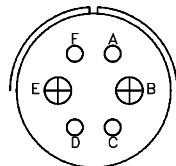
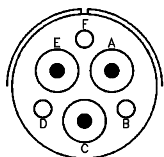

DISPOSICIÓN **20-22**
TAMAÑO CONTACTOS **3/8 , 3/16**
RANGO SERVICIO **A**

DISPOSICIÓN **22-5**
TAMAÑO CONTACTOS **2/12 , 4/16**
RANGO SERVICIO **D**

DISPOSICIÓN **22-15**
TAMAÑO CONTACTOS **5/12 , 1/16**
RANGO SERVICIO **D=E ; A,B,C,E,F=A**

DISPOSICIÓN **22-24**
TAMAÑO CONTACTOS **2/12 , 4/16**
RANGO SERVICIO **A,B,F=A ; C,D,E=D**

DISPOSICIÓN **24-06**
TAMAÑO CONTACTOS **4/8 , 2/16**
RANGO SERVICIO **D**

SÍMBOLO DE LOS CONTACTOS
CONTACTLEGEND

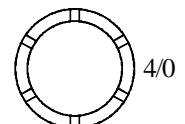

Disposición de los contactos

Contact arrangement

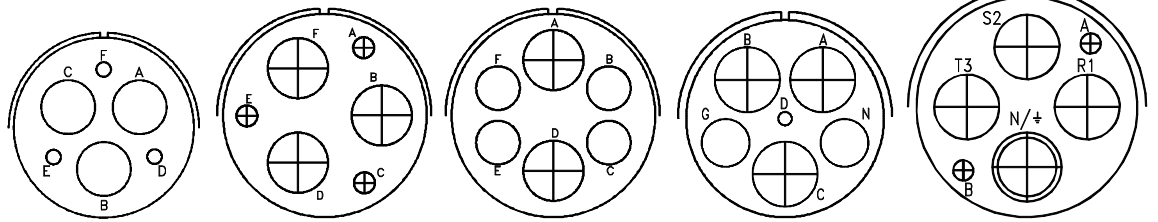

DISPOSICIÓN	28-22	36-3	36-6	36-A51	40-A4
TAMAÑO CONTACTOS	3/4 , 3/16	3/0 , 3/12	2/0 , 4/4	3/0 , 2/4 , 1/16	1/0M , 3/0 , 2/12
RANGO DE SERVICIO	D	D	A	D	A

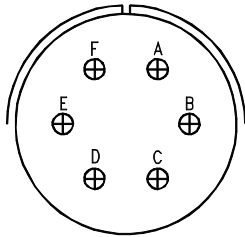

ARRANGEMENT	40-A6
CONTACT SIZE	16
SERVICE RATING	B

7 CONTACTOS

7 CONTACTS

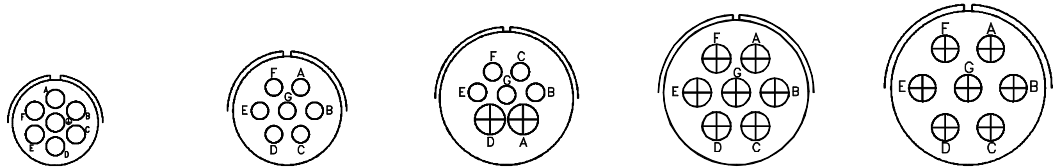

DISPOSICIÓN	14-07	16S-1	18-9	20-15	22-28
TAMAÑO CONTACTOS	16	16	2/12 , 5/16	12	12
RANGO DE SERVICIO	I	A	I	A	A

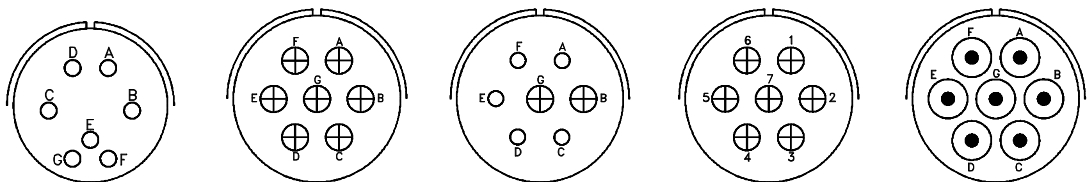

ARRANGEMENT	22-33	24-2	24-3	24-07	24-10
CONTACT SIZE	16	12	2/12 , 5/16	12	8
SERVICE RATING	A,B,C,D=D ; E,F,G=A	D	A	D	A

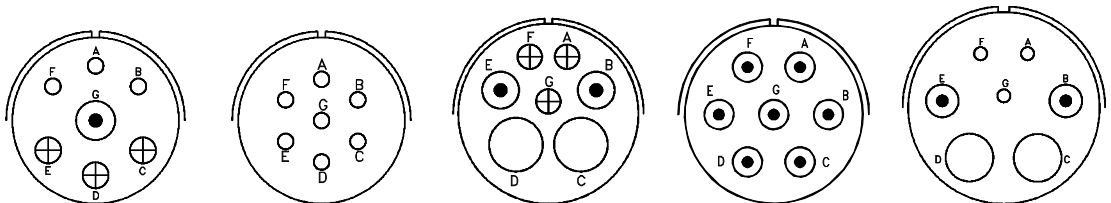

DISPOSICIÓN	24-16	24-27	28-10	28-70	32-10
TAMAÑO CONTACTOS	1/8 , 3/12 , 3/16	16	2/4 , 2/8 , 3/12	8	2/4 , 2/8 , 3/16
RANGO DE SEVICIO	A,B,F,G=D ; C,D,E=A	E	G=D ; Bal=A	A	A,F=E ; B,E=D ; C,D=A ; G=B

SIMBOLO DE LOS CONTACTOS

CONTACTLEGEND

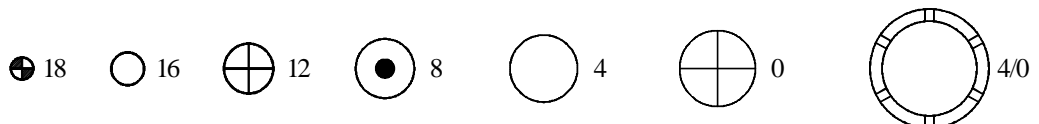

8 CONTACTOS
8 CONTACTS

ARRANGEMENT
CONTACT SIZE
SERVICE RATING

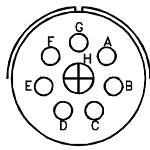

18-8
1/12 , 7/16
A

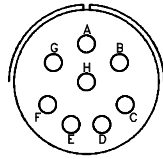

20-7
16
A,B,H,G=D ;
C,D,E,F=A

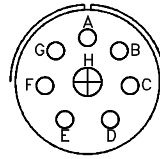

20-9
1/12 , 7/16
H=D ; Bal=A

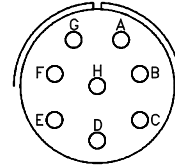

22-18
16
A,B,F,G,H=D ;
C,D,E=A

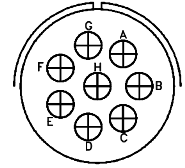

22-23
12
H=D ; Bal=A

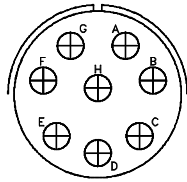

DISPOSICIÓN
TAMAÑO CONTACTOS
RANGO DE SERVICIO

24-6
12
A,G,H,=D ; Bal=A

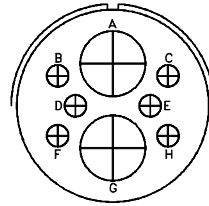

32-15
2/0 , 6/12
D

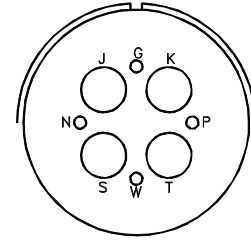

40-A10
4/4 , 4/16
D

9 CONTACTO
9 CONTACTS

ARRANGEMENT
CONTACT SIZE
SERVICE RATING

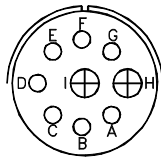

20-16
2/12 , 7/16
A

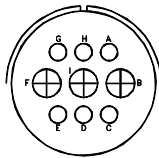

20-18
3/12 , 6/16
A

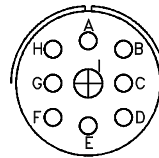

20-21
1/12 , 8/16
A

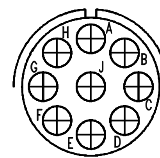

20-A9
12
J=D ; Bal=I

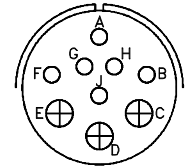

22-16
3/12 , 6/16
A

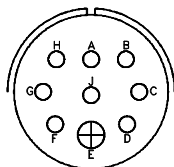

DISPOSICIÓN
TAMAÑO CONTACTOS
RANGO DE SERVICIO

22-17
1/12 , 8/16
A=D ; Bal=A

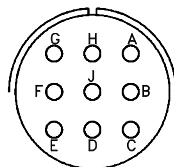

22-20
16
A

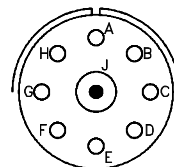

22-27
1/8 , 8/16
J=D ; Bal=A

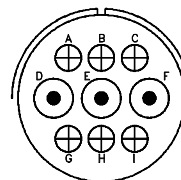

24-11
3/8 , 6/12
A

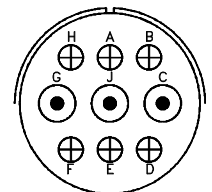

28-1
3/8 , 6/12
A,J,E=D ; Bal=A

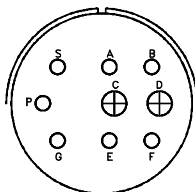

ARRANGEMENT
CONTACT SIZE
SERVICE RATING

28-4
2/12 , 7/16
G,P,S=E ; Bal=D

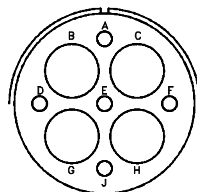

28-09
4/4 , 5/16
A

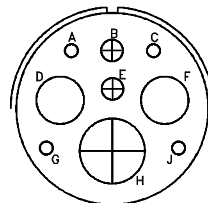

32-3
1/0 , 2/4 , 2/12 , 4/16
D

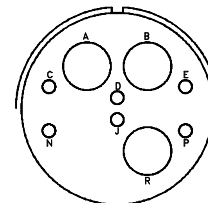

32-689
3/4 , 6/16
A

SIMBOLO DE LOS
CONTACTOS
CONTACTLEGEND

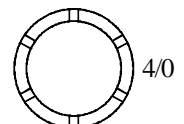

Disposición de los contactos

Contact arrangement

10 CONTACTOS

10 CONTACTS

ARRANGEMENT
CONTACT SIZE
SERVICE RATING

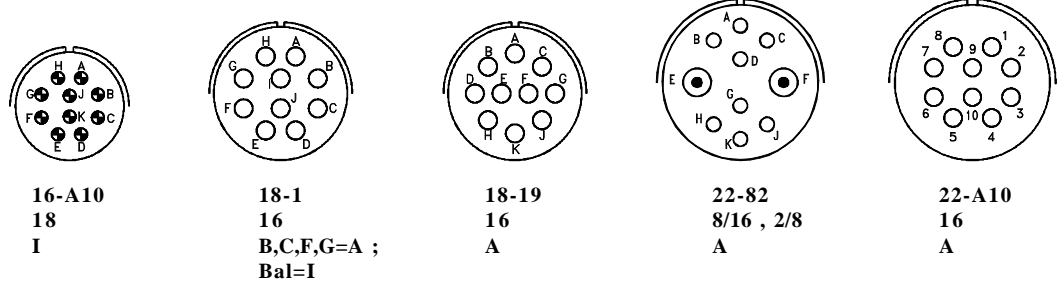

DISPOSICIÓN
TAMAÑO CONTACTOS
RANGO DE SERVICIO

16-A10
18
I

18-1
16
B,C,F,G=A ;
Bal=I

18-19
16
A

22-82
8/16 , 2/8
A

22-A10
16
A

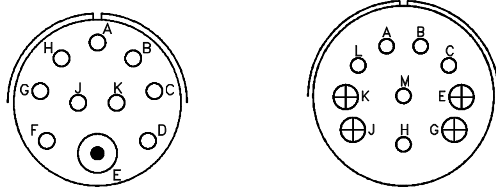

DISPOSICIÓN
TAMAÑO CONTACTOS
RANGO DE SERVICIO

24-21
1/8 , 9/16
D

28-19
4/12 , 6/16
A,B=D ; K,M=B ; Bal=A

11 CONTACTOS

11 CONTACTS

ARRANGEMENT
CONTACT SIZE
SERVICE RATING

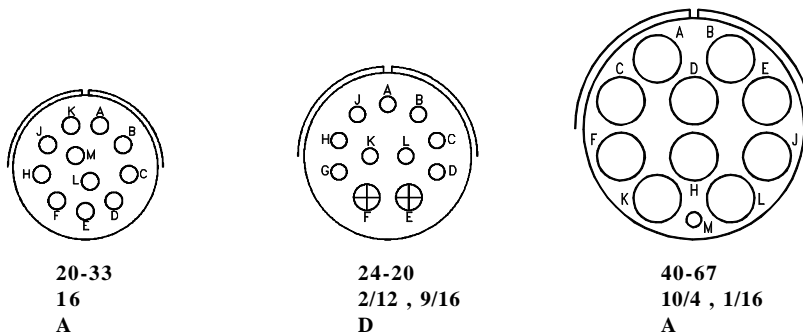

20-33
16
A

24-20
2/12 , 9/16
D

40-67
10/4 , 1/16
A

12 CONTACTOS

12 CONTACTS

DISPOSICIÓN
TAMAÑO CONTACTOS
RANGO DE SERVICIO

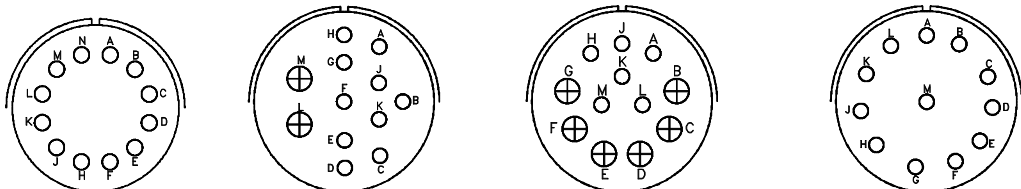

24-19
16
A

28-8
2/12 , 10/16
B=D ; L,M=E ; Bal=A

28-9
6/12 , 6/16
D

28-18
16
A,B=A ; G,H,J,K,L=D ;
M=C ; Bal=I

13 CONTACTOS

13 CONTACTS

ARRANGEMENT
CONTACT SIZE
SERVICE RATING

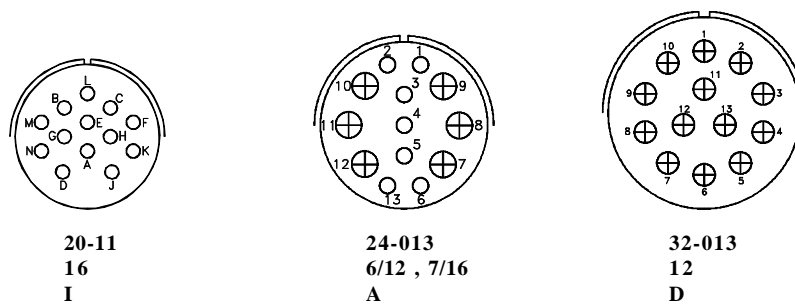

20-11
16
I

24-013
6/12 , 7/16
A

32-013
12
D

SIMBOLO DE LOS CONTACTOS
CONTACT LEGEND

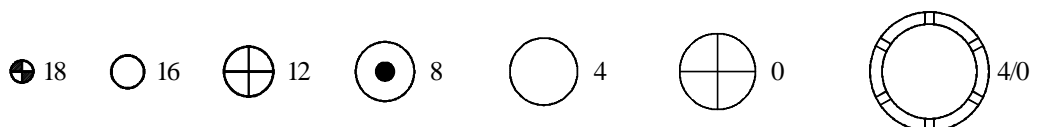

14 CONTACTOS
14 CONTACTS

DISPOSICIÓN
TAMAÑO CONTACTOS
RANGO DE SERVICIO

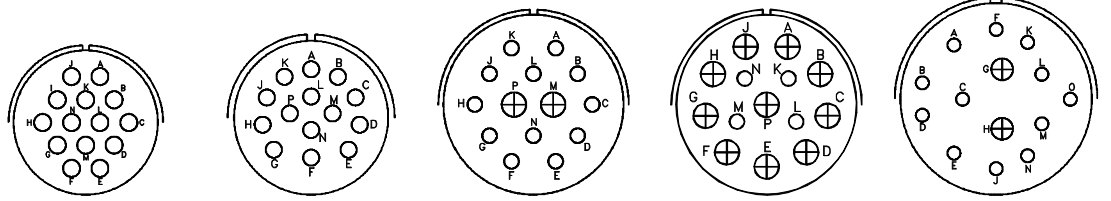

20-27	22-19	28-2	28-20	32-4
16	16	2/12, 12/16	10/12, 4/16	2/12, 12/16
A	A	D	A	F,J,K,N=A ; Bal=A

ARRANGEMENT
CONTACT SIZE
SERVICE RATING

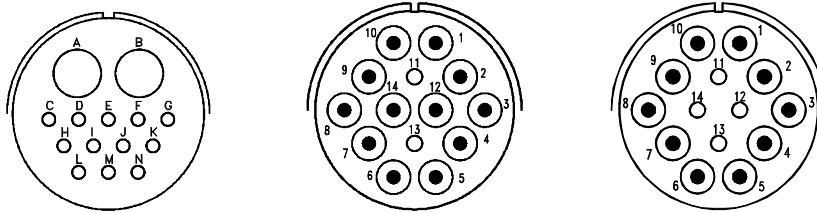

32-9	36-B78	36-D78
2/4, 12/16	12/8, 2/16	10/8, 4/16
A	D	D

15 CONTACTOS
15 CONTACTS

DISPOSICIÓN
TAMAÑO CONTACTOS
RANGO DE SERVICIO

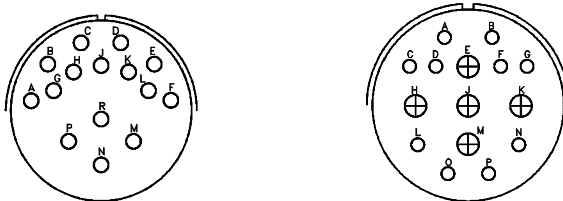

28-17	32-12
16	5/12, 10/16
M,N,P=D ; R=B ; Bal=A	C,D,E,F,G,=A ; Bal=D

16 CONTACTOS
16 CONTACTS

ARRANGEMENT
CONTACT SIZE
SERVICE RATING

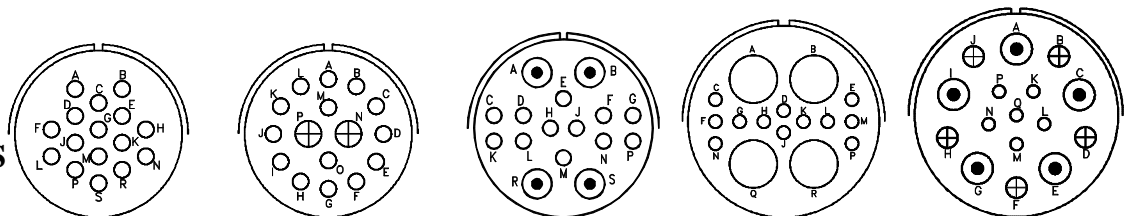

24-5	24-7	28-124	32-68	36-14
16	2/12, 14/16	12/16, 4/8	4/4, 12/16	5/8, 5/12, 6/16
A	A	A	A	D

17 CONTACTOS
17 CONTACTS

DISPOSICIÓN
TAMAÑO CONTACTOS
RANGO DE SERVICIO

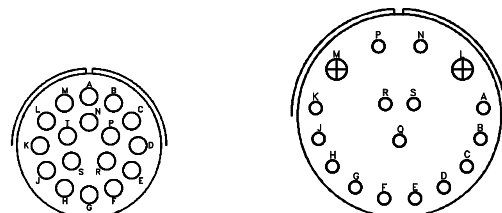

20-29	36-13
16	2/12, 15-16
A	N,P,Q=E ; Bal=E

SÍMBOLO DE LOS CONTACTOS
CONTACTLEGEND

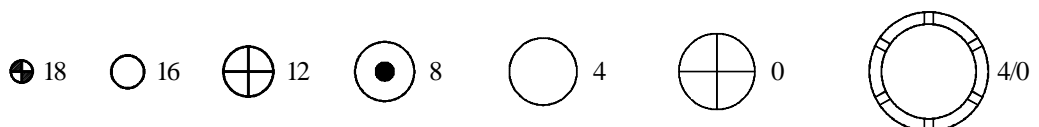

Disposición de los contactos

Contact arrangement



19 CONTACTOS

19 CONTACTS

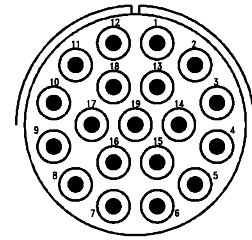
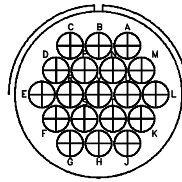
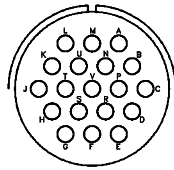
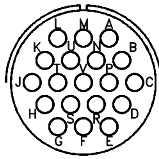

DISPOSICIÓN 20-A48
TAMAÑO CONTACTOS 16
RANGO DE SERVICIO I

22-14
16
A

24-67
12
A

40-B19
8
A

20 CONTACTOS

20 CONTACTS

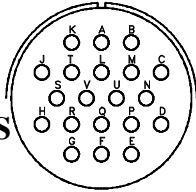

ARRANGEMENT 28-16
CONTACT SIZE 16
SERVICE RATING A

22 CONTACTOS

22 CONTACTS

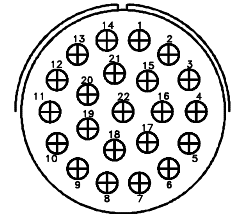
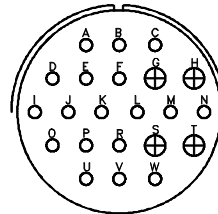
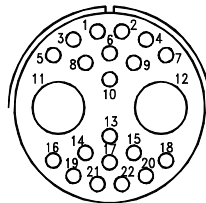
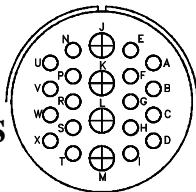

DISPOSICIÓN 28-11
TAMAÑO CONTACTOS 4/12 , 18/16
RANGO DE SERVICIO A

32-B22
2/4 , 20/16
A

36-1
4/12 , 18/16
D

36-22
12
D

23 CONTACTOS

23 CONTACTS

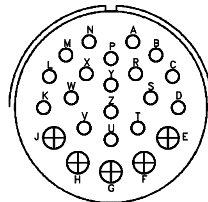
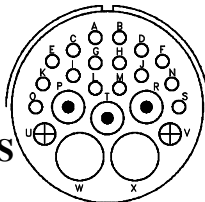

24 CONTACTOS

24 CONTACTS

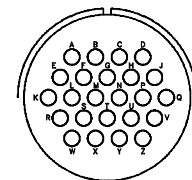

ARRANGEMENT 32-6
CONTACT SIZE 2/4 , 3/8 , 2/12 , 16/16
SERVICE RATING A

32-13
5/12 , 18/16
D

24-28
16
I

25 CONTACTOS

25 CONTACTS

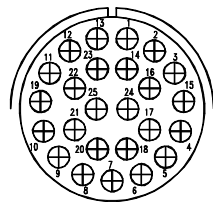
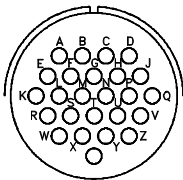

26 CONTACTOS

26 CONTACTS

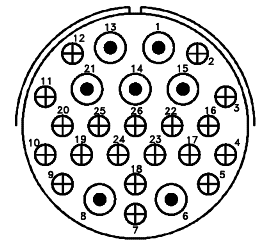
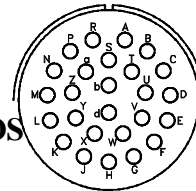

DISPOSICIÓN 24-A25
TAMAÑO CONTACTOS 16
RANGO DE SERVICIO A

32-A25
12
A

28-12
16
A

40-26
7/8 , 19/12
A

SÍMBOLO DE LOS CONTACTOS

CONTACT LEGEND



27 CONTACTOS
27 CONTACTS

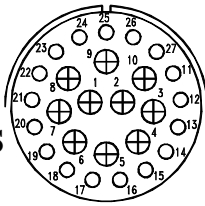

DISPOSICIÓN 32-A27
TAMAÑO CONTACTOS 10/12 , 17/16
RANGO DE SERVICIO A

28 CONTACTOS
28 CONTACTS

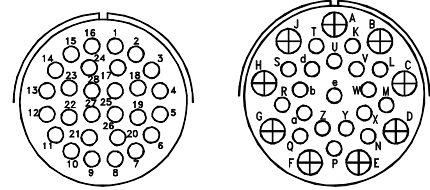

24-A28 28-A63
16 9/12 , 19/16
I I

29 CONTACTOS
29 CONTACTS

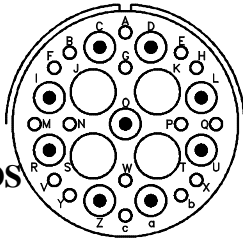

ARRANGEMENT 40-10
CONTACT SIZE 4/4 , 9/8 , 16/16
SERVICE RATING A

30 CONTACTOS
30 CONTACTS

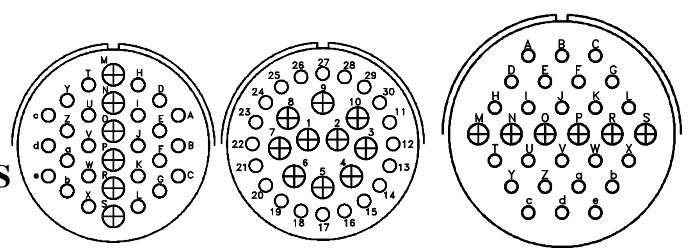

32-8 32-A30 40-1
6/12 , 24/16 10/12 , 20/16 6/12 , 20/16
A A D

31 CONTACTOS
31 CONTACTS

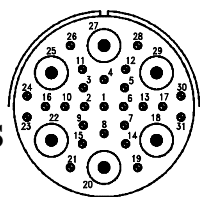

DISPOSICIÓN 28-A31
TAMAÑO CONTACTOS 6/8 , 25/18
RANGO DE SERVICIO A

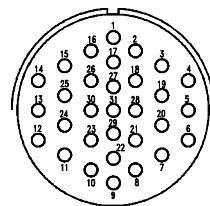

32-31
1/4 , 2/8 , 14/12 , 14/16
A

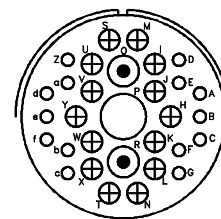

36-9
12
A

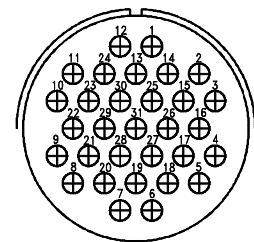

40-31
15/8 , 16/16
D

ARRANGEMENT 40-A51
CONTACT SIZE 15/8 , 16/16
SERVICE RATING A

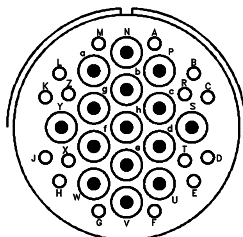

34 CONTACTOS
34 CONTACTS

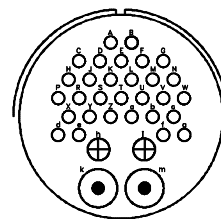

36-20
2/8 , 2/12 , 30/16
A

35 CONTACTOS
35 CONTACTS

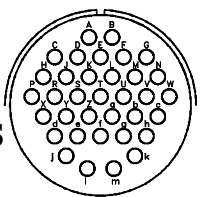

DISPOSICIÓN 28-15
TAMAÑO CONTACTOS 16
RANGO DE SERVICIO A

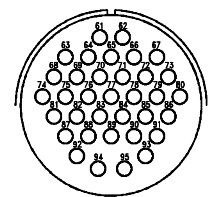

28-A35
16
A

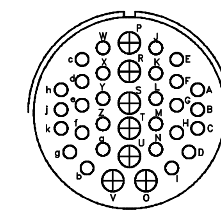

32-7
7/12 , 28/16
A,B,h,j=I ; Bal=A

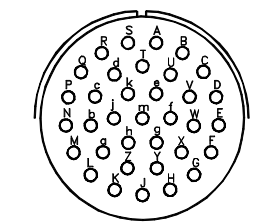

36-15
16
M=D ; Bal=A

SÍMBOLO DE LOS CONTACTOS
CONTACTLEGEND



Disposición de los contactos

Contact arrangement

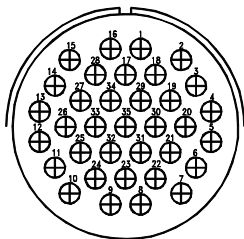

36 CONTACTOS
36 CONTACTS

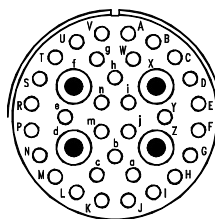

36-35
4/8 , 32/12
A

ARRANGEMENT 40-35
CONTACT SIZE 12
SERVICE RATING D

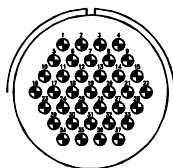

37 CONTACTOS
37 CONTACTS

ARRANGEMENT 22-A37
CONTACT SIZE 18
SERVICE RATING A

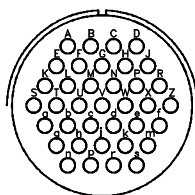

28-21
16
A

38 CONTACTOS
38 CONTACTS

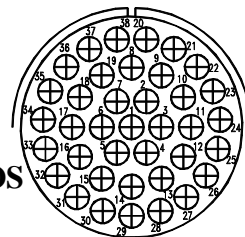

40-A38
12
A

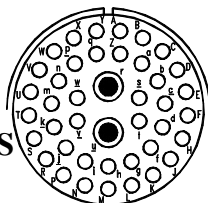

42 CONTACTOS
42 CONTACTS

ARRANGEMENT 32-59
CONTACT SIZE 2/8 , 40/16
SERVICE RATING A

44 CONTACTOS
44 CONTACTS

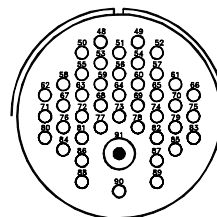

36-74
1/8 , 43/16
A

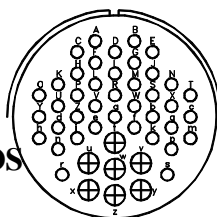

47 CONTACTOS
47 CONTACTS

ARRANGEMENT 36-7
CONTACT SIZE 7/12 , 40/16
SERVICE RATING A

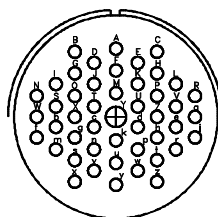

36-8
1/12 , 46/16
A

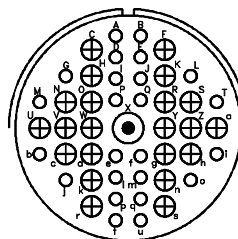

40-9
1/8 , 22/12 , 24/16
A

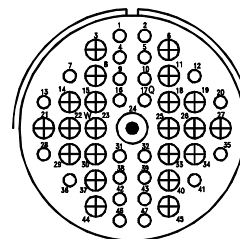

40-47
1/8 , 22/12 , 24/16
A

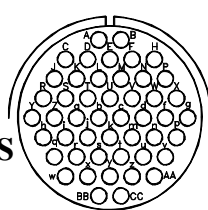

48 CONTACTOS
48 CONTACTS

ARRANGEMENT 32-A48
CONTACT SIZE 16
SERVICE RATING I

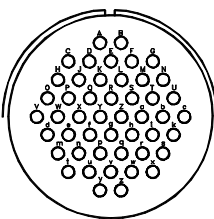

36-10
16
A

51 CONTACTOS
51 CONTACTS

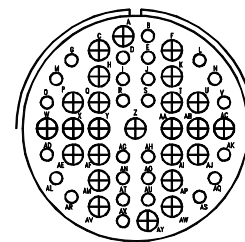

40-951
25/12 , 26/16
A

SIMBOLO DE LOS CONTACTOS
CONTACTLEGEND



54 CONTACTOS
54 CONTACTS

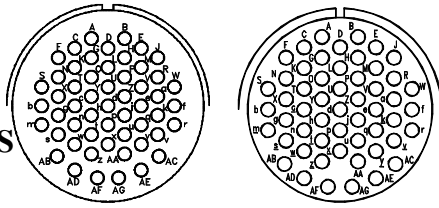

DISPOSICIÓN	32-22	32-88
TAMAÑO CONTACTOS	16	16
RANGO DE SERVICIO	A	A

60 CONTACTS
60 CONTACTOS

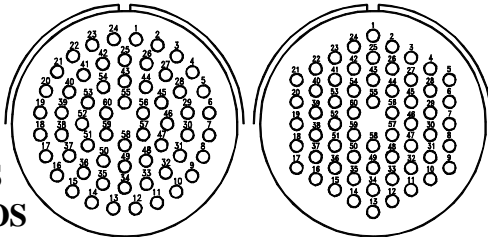

ARRANGEMENT	40-53	40-62
CONTACT SIZE	16	16
SERVICE RATING	A	A

61 CONTACTS
61 CONTACTS

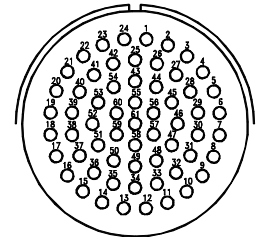

ARRANGEMENT	40-63
CONTACT SIZE	16
SERVICE RATING	A

62 CONTACTS
62 CONTACTS

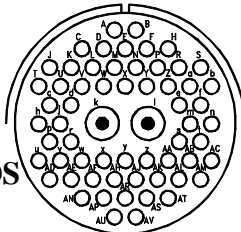

DISPOSICIÓN	40-A62
TAMAÑO CONTACTOS	2/8 , 60/16
RANGO DE SERVICIO	A

65 CONTACTS
65 CONTACTS

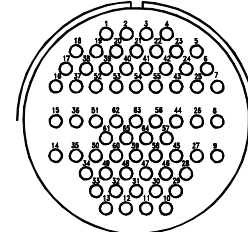

DISPOSICIÓN	40-A65
TAMAÑO CONTACTOS	16
RANGO DE SERVICIO	A

72 CONTACTS
72 CONTACTS

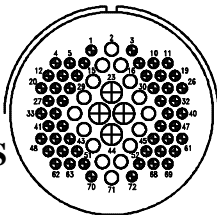

ARRANGEMENT	36-A72
CONTACT SIZE	4/12 , 16/16 , 52/18
SERVICE RATING	I

85 CONTACTS
85 CONTACTS

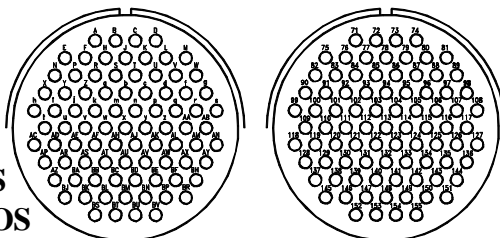

DISPOSICIÓN	40-56	40-A56
TAMAÑO CONTACTOS	16	16
RANGO DE SERVICIO	A	A

150 CONTACTS
150 CONTACTS

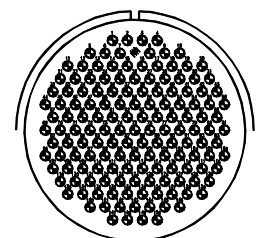

DISPOSICIÓN	40-150
TAMAÑO CONTACTOS	18
RANGO DE SERVICIO	I

SÍMBOLO DE LOS CONTACTOS
CONTACTLEGEND

